



**■ Features**

- 3 $\phi$  3-wire /  $\Delta$  196~305VAC or 3 $\phi$  4-wire / Y 340~530VAC wide input range
- Built-in active PFC function
- High efficiency up to 91%
- Protections: Short circuit / Overload / Over voltage / Over temperature / Fan fail
- Forced air cooling by built-in fan with speed control function
- Output voltage can be trimmed between 20~120% by 1~6VDC external control signal
- Output current can be trimmed between 20~100% by 1~5VDC external control signal
- Current sharing up to 2 units
- Alarm signal output (relay contact and open collector signal): AC fail, DC OK, fan fail, OTP
- Built-in 12V/0.1A auxiliary output for remote control
- Built-in remote ON/OFF control
- Built-in remote sense function
- 5 years warranty

**■ Applications**

- Industrial control equipments
- Automation equipments
- Laser engravers
- Telecommunication systems

**■ Description**

RST-10000 is one 10000W single output enclosed type AC/DC power supply series. This series accepts the wide range 3-phase AC input (3 $\phi$  3-wire /  $\Delta$  196~305VAC or 3 $\phi$  4-wire / Y 340~530VAC) and supplies 24VDC, 36VDC and 48VDC at the output. RST-10000 particularly provides the wide range adjustment function for output voltage and current by means of an external control signal; moreover, RST-10000 offers two overload protection mechanisms, the “continuous constant current limiting” mode and the “constant current limiting with delay shutdown after 5 seconds” mode, well providing the flexibility for high power system design.

RST-10000 has the built-in active PFC function and the working efficiency is high up to 91%. With the built-in fan, the entire series can supply the full load output under 50°C ambient temperature. The parallel function is built to transmit an even higher power with up to 2 units. Other functions include the remote sense function, the 12V/0.1A auxiliary power, the alarm signal output (both relay contact and open collector signal) for AC fail, DC OK, fan fail, over temperature protection, etc. RST-10000 series acquires the major global safety regulation certificates.

**■ Model Encoding**

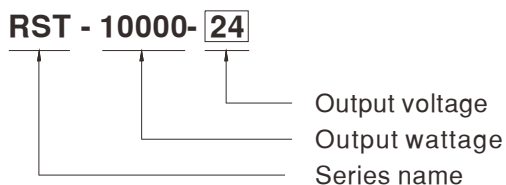

**SPECIFICATION**

MODEL		RST-10000-24	RST-10000-36	RST-10000-48
OUTPUT	DC VOLTAGE	24V	36V	48V
	RATED CURRENT	400A	276A	210A
	CURRENT RANGE	0 ~ 400A	0 ~ 276A	0 ~ 210A
	RATED POWER	9600W	9936W	10080W
	RIPPLE & NOISE (max.) Note.2	150mVp-p	200mVp-p	200mVp-p
	VOLTAGE ADJ. RANGE Note.4	23.5 ~ 28.8V	35 ~ 43.2V	47 ~ 57.6V
	VOLTAGE TOLERANCE Note.3	±1.0%	±1.0%	±1.0%
	LINE REGULATION	±0.5%	±0.5%	±0.5%
	LOAD REGULATION	±0.5%	±0.5%	±0.5%
	SETUP, RISE TIME	2200ms, 80ms at full load		
HOLD UP TIME (Typ.)	20ms / 230VAC at 75% load      14ms / 230VAC at full load			
INPUT	VOLTAGE RANGE	3 $\phi$ 3-wire / $\Delta$ 196 ~ 305VAC or 3 $\phi$ 4-wire / Y 340 ~ 530VAC		
	FREQUENCY RANGE	47 ~ 63Hz		
	POWER FACTOR (Typ.)	0.95/230VAC(400VAC) at full load		
	EFFICIENCY (Typ.)	89%	90%	91%
	AC CURRENT (Typ.)	30A/230VAC(3 $\phi$ 3-wire / $\Delta$ )	18A/400VAC(3 $\phi$ 4-wire / Y)	
	INRUSH CURRENT (Typ.)	150A/230VAC(3 $\phi$ 3-wire / $\Delta$ )	100A/400VAC(3 $\phi$ 4-wire / Y)	
	LEAKAGE CURRENT	<7mA / $\Delta$ 305VAC(Y 530VAC)		
PROTECTION	OVERLOAD	100 ~ 112% rated output power User adjustable continuous constant current limiting or constant current limiting with delay shutdown after 5 seconds, re-power on to recover		
	OVER VOLTAGE	30 ~ 33.6V	45 ~ 50.4V	60 ~ 67.2V
	OVER TEMPERATURE	Shut down o/p voltage, recovers automatically after temperature goes down		
FUNCTION	AUXILIARY POWER(AUX)	12V@0.1A(Only for Remote ON/OFF control)		
	REMOTE ON/OFF CONTROL	Please refer to the Function Manual		
	ALARM SIGNAL OUTPUT	Please refer to the Function Manual		
	OUTPUT VOLTAGE TRIMMING	Adjustment of output voltage is allowable between 20 ~ 120% by 1 ~ 6VDC external control signal		
	OUTPUT CURRENT TRIMMING	Adjustment of output current is allowable between 20 ~ 100% by 1 ~ 5VDC external control signal		
	CURRENT SHARING	Please refer to the Function Manual		
ENVIRONMENT	WORKING TEMP.	-30 ~ +70°C (Refer to "Derating Curve")		
	WORKING HUMIDITY	20 ~ 90% RH non-condensing		
	STORAGE TEMP., HUMIDITY	-40 ~ +85°C, 10 ~ 95% RH		
	TEMP. COEFFICIENT	±0.03%/°C (0 ~ 50°C)		
	VIBRATION	10 ~ 500Hz, 2G 10min./1cycle, 60min. each along X, Y, Z axes		
SAFETY & EMC (Note 6)	SAFETY STANDARDS	UL60950-1, TUV EN60950-1 approved		
	WITHSTAND VOLTAGE Note.5	I/P-O/P:3KVAC    I/P-FG:2KVAC    O/P-FG:0.5KVAC		
	ISOLATION RESISTANCE Note.5	I/P-O/P, I/P-FG, O/P-FG:100M Ohms / 500VDC / 25°C / 70% RH		
	EMC EMISSION	Compliance to EN55022 (CISPR22) Class A, EN61000-3-2,-3		
OTHERS	EMC IMMUNITY	Compliance to EN61000-4-2,3,4,5,6,8,11, EN55024, EN61000-6-2, heavy industry level, criteria A		
	MTBF	18.7K hrs min.    MIL-HDBK-217F (25°C)		
	DIMENSION	540*424*83.5mm (L*W*H)		
NOTE	PACKING	23.5Kg; 1pcs/23.5Kg/2.45CUFT		
	<p>1. All parameters NOT specially mentioned are measured at <math>\Delta</math>230VAC(Y 400VAC) input, rated load and 25°C of ambient temperature.  2. Ripple &amp; noise are measured at 20MHz of bandwidth by using a 12" twisted pair-wire terminated with a 0.1uf &amp; 47uf parallel capacitor.  3. Tolerance : includes set up tolerance, line regulation and load regulation.  4. Adjusted through potentiometer.  5. During withstandstandards voltage and isolation resistance testing, the screw "A" shall be temporarily removed, and shall be installed back after the testing.  6. The power supply is considered a component which will be installed into a final equipment. The final equipment must be re-confirmed that it still meets EMC directives. For guidance on how to perform these EMC tests, please refer to EMI testing of component power supplies.  (as available on <a href="http://www.meanwell.com">http://www.meanwell.com</a>)</p>			

■ Block Diagram

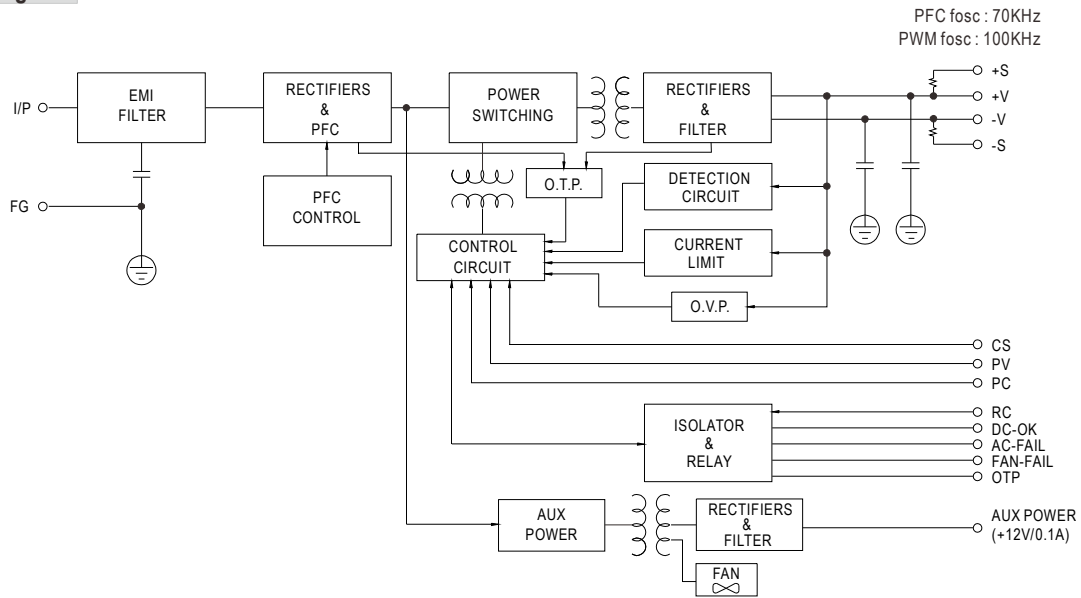

■ Derating Curve

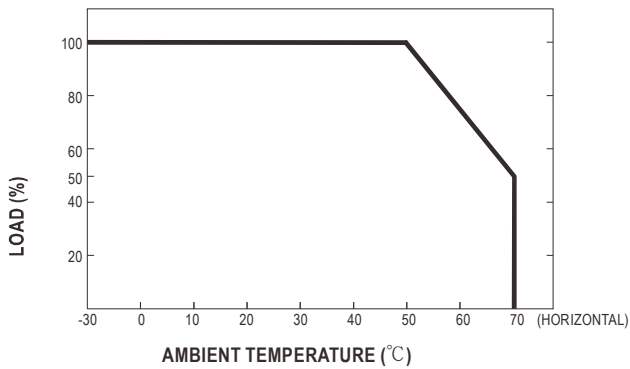

■ Static Characteristics

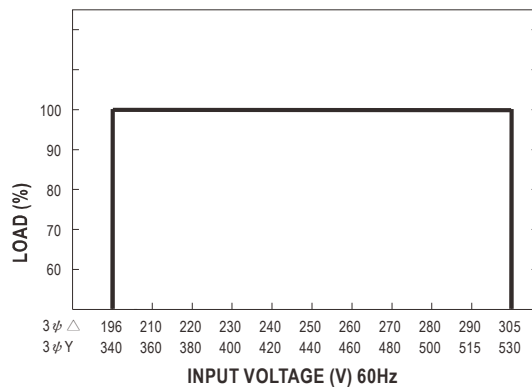

■ Function Description of CN992, 993

Pin No.	Function	Description
1	CS-	Current sharing signal. When units are connected in parallel, the CS pins of the units should be connected to allow current balance between units. Please refer to the Function Manual section for details.
2	CS+	
3	+S	The +S signal should be connected to the positive terminal of the load. The +S and -S leads should be twisted in pair to minimize noise pick-up effect. The maximum line drop compensation is 0.5V.
5	-S	
4	PV-	Connect to external DC voltage source for output voltage trimming. Output voltage can be trimmed between 20 ~ 120% of the rated output voltage. Please refer to the Function Manual section for details.
6	PV+	
7	PC-	Connect to external DC voltage source for output current trimming. Output current can be trimmed between 20 ~ 100% of the rated output current. Please refer to the Function Manual section for details.
9	PC+	
8	RC-	The output can be turned ON/OFF by the electrical signal between RC+ and RC-. Please refer to the Function Manual section for details.
10	RC+	

■ Function Description of CN991

Pin No.	Function	Description
1	12V-AUX	Auxiliary voltage output, 11.4~12.6V, referenced to pin 3(GND-AUX). The maximum load current is 0.1A. This output is not controlled by the "Remote ON/OFF" function.
2	DC-OK2-GND	Alarm signal of DC-OK. Open collector signal. Low when the PSU turns on. The maximum sink current is 10mA and the maximum external voltage is 20V.
4	DC-OK2	
3	GND-AUX	Auxiliary voltage output GND. The signal return is isolated from the output terminals (+V & -V).
5	+V	PSU output +V signal.
6	AC-FAIL2-GND	Alarm signal of AC fail. Open collector signal. Low when the PSU input voltage is too low. The maximum sink current is 10mA and the maximum external voltage is 20V.
8	AC-FAIL2	
7	-V	PSU output -V signal.
9	OTP2	Alarm signal of OTP. Open collector signal. Low when the PSU over temperature protection occurs. The maximum sink current is 10mA and the maximum external voltage is 20V.
11	OTP2-GND	
10	FAN-FAIL2	Alarm signal of fan fail. Open collector signal. Low when the internal fan fails. The maximum sink current is 10mA and the maximum external voltage is 20V.
12	FAN-FAIL2-GND	
13	OTP1	Alarm signal of OTP. Normally open contact. "Short" when the PSU over temperature protection occurs. Relay contact rating(maximum) is 30V/1A resistive.
15	OTP1-GND	
14	DC-OK1	Alarm signal of DC-OK. Normally open contact. "Short" when the PSU turns on. Relay contact rating(maximum) is 30V/1A resistive.
16	DC-OK1-GND	
17	AC-FAIL1-GND	Alarm signal of AC-fail. Normally open contact. "Short" when the PSU input voltage is too low. Relay contact rating(maximum) is 30V/1A resistive.
19	AC-FAIL1	
18	FAN-FAIL1-GND	Alarm signal of fan fail. Normally open contact. "Short" when the internal fan fails. Relay contact rating(maximum) is 30V/1A resistive.
20	FAN-FAIL1	

■ Function Manual

1.Remote ON/OFF Control

The PSU can be turned ON/OFF by using the "Remote ON/OFF" function.

Between ON/OFF(CN992 or CN993 pin10) and 12V-AUX(CN991 pin1)	Output Status
SW close (Short)	PSU ON
SW open (Open)	PSU OFF

Table 1.1

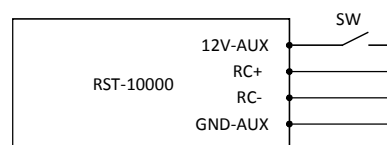

Fig 1.1

**2.Remote Sense**

The remote sense function compensates the voltage drop on the cable, between the PSU and the load, up to 0.3V. If the remote sense function is not required, +S and +V, as well as -S and -V, need to be connected to be free from noise and interference. (+S and +V, -S and -V are connected as factory default setting)

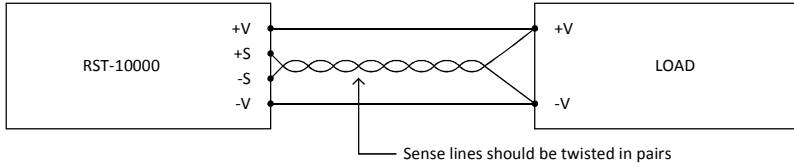

Fig 2.1

**3.Select PV mode (Output Voltage Trimming)**

(1)SVR mode

- (a)Have the DIP switch position-3 set as
- (b)Output voltage can be trimmed by SVR.

(2)PV mode

- (a)Have the DIP switch position-3 set as
- (b)Connect an external DC source between PV+ and PV- on CN992 or CN993.
- (c)+S and +V, as well as -S and -V, need to be connected as shown in Fig 3.1.
- (d)Trimming of output voltage is allowed between 20~120%(Typ.) of the rated output voltage as is shown in Fig 3.2.

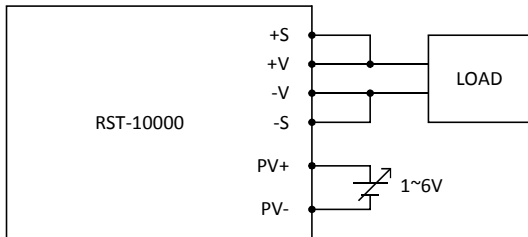

Fig 3.1

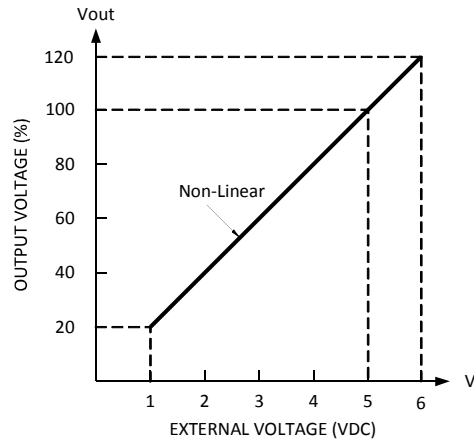

Fig 3.2

**4.Select PC Mode (Output Current Trimming)**

(1)Default OLP value

- (a)Have the DIP switch position-2 set as
- (b)Output current is set default value.

(2)PC mode

- (a)Have the DIP switch position-2 set as
- (b)Connect an external voltage source between PC+ and PC- on CN992 or CN993 as shown in Fig 4.1.
- (c)Trimming of output current is allowed between 20~100%(Typ.) of the rated output current as shown in Fig 4.2.

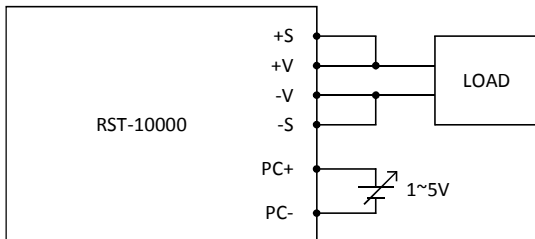

Fig 4.1

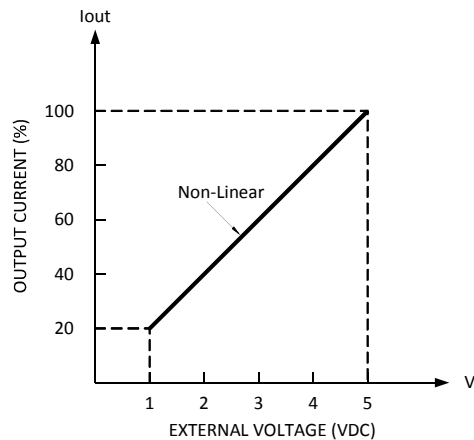



Fig 4.2

**5. Select OLP Mode**

(1) Continuous Constant Current mode

Have the DIP switch position-1 set as , and RST-10000 will work in continuous constant current mode when the output is overloaded or short-circuited.

(2) Delay Shutdown mode

Have the DIP switch position-1 set as , and RST-10000 will shut down after 5 seconds of constant current operation, when the output is overloaded or short-circuited.

**6. Front Panel Indicators**

LED	Description
GREEN(LED1)	LED on when output voltage is OK
RED(LED2)	LED on when any protection occurs

Table 6.1

**7. Alarm Signal Output**

There are 4 alarm signals on CN991, and each signal can select two types of output circuit.

(1) Relay contact output

Normally open contact. "Short" when the alarm arises. Relay contact rating(maximum) is 30V/1A resistive.

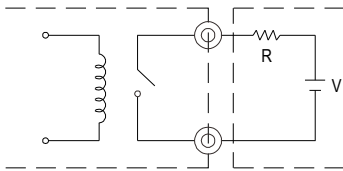

Fig 7.1

(2) Open collector output

An external voltage source is required for this function that is shown in Fig 7.2. These signals are isolated from output. The maximum sink current is 10mA and the maximum external voltage is 20V (there is a built-in 24V zener diode in inner circuitry).

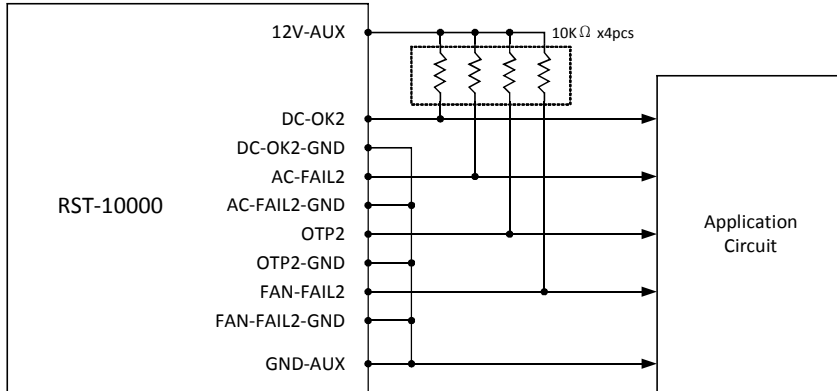
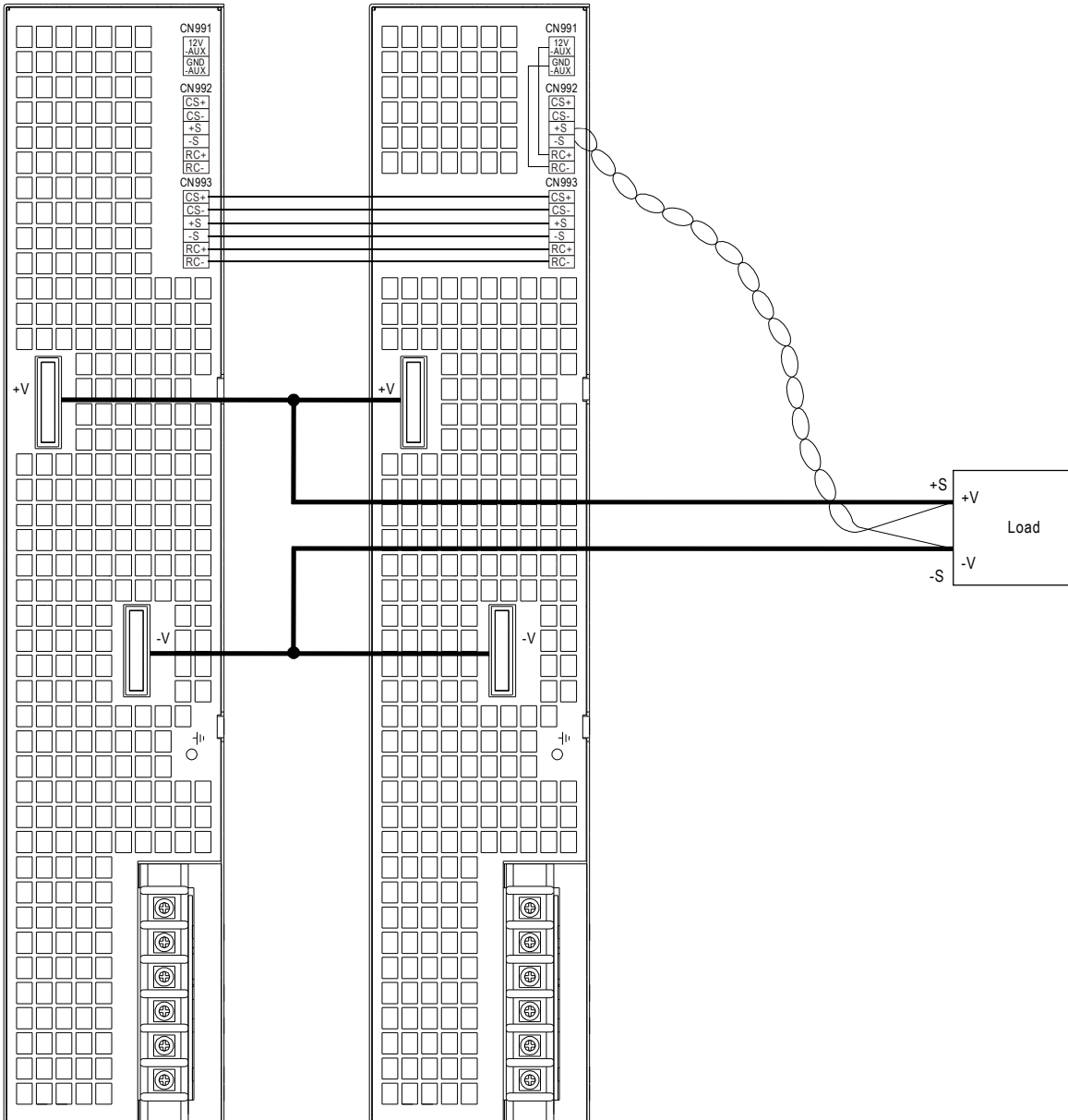

Fig 7.2

**8.Current Sharing**

- (1) Parallel operation is available by connecting the units shown as follows. (+S,-S and CS+, CS- and RC+, RC- are connected mutually in parallel.)
- (2) The voltage difference among each output should be minimized that less than 0.2V is required.
- (3) The total output current must not exceed the value determined by the following equation.  
 (Output current at parallel operation)=(The rated current per unit)x(Number of unit)x0.9
- (4) In parallel operation 2 units is the maximum, please consult the manufacturer for other applications.
- (5) When the remote sense function is used in parallel operation, the sensing wire must be connected only to the master unit.
- (6) Wires of the remote sense function should be kept at least 30 cm from input wires.
- (7) When in parallel operation, the minimum output load should be greater than 5% of the total output load.  
 (Min. Load) > (5% rated current per unit) x (number of unit)



**9.AC Power Connection**

◎3 $\phi$  3-wire /  $\Delta$  230VAC

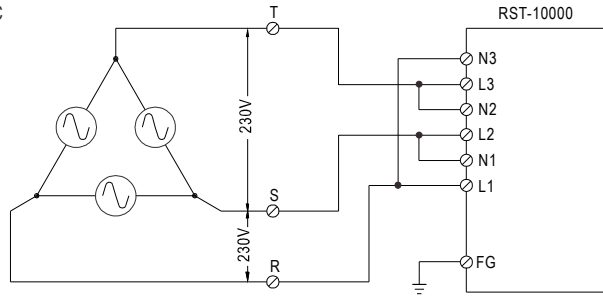

Fig 9.1

◎3 $\phi$  4-wire / Y 400VAC

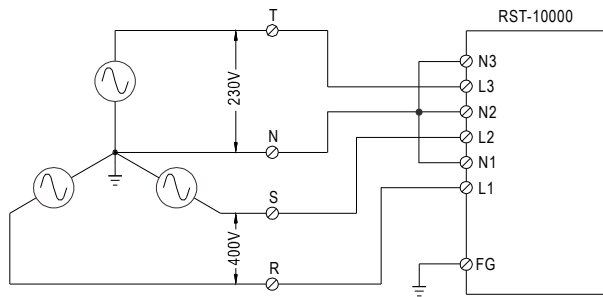
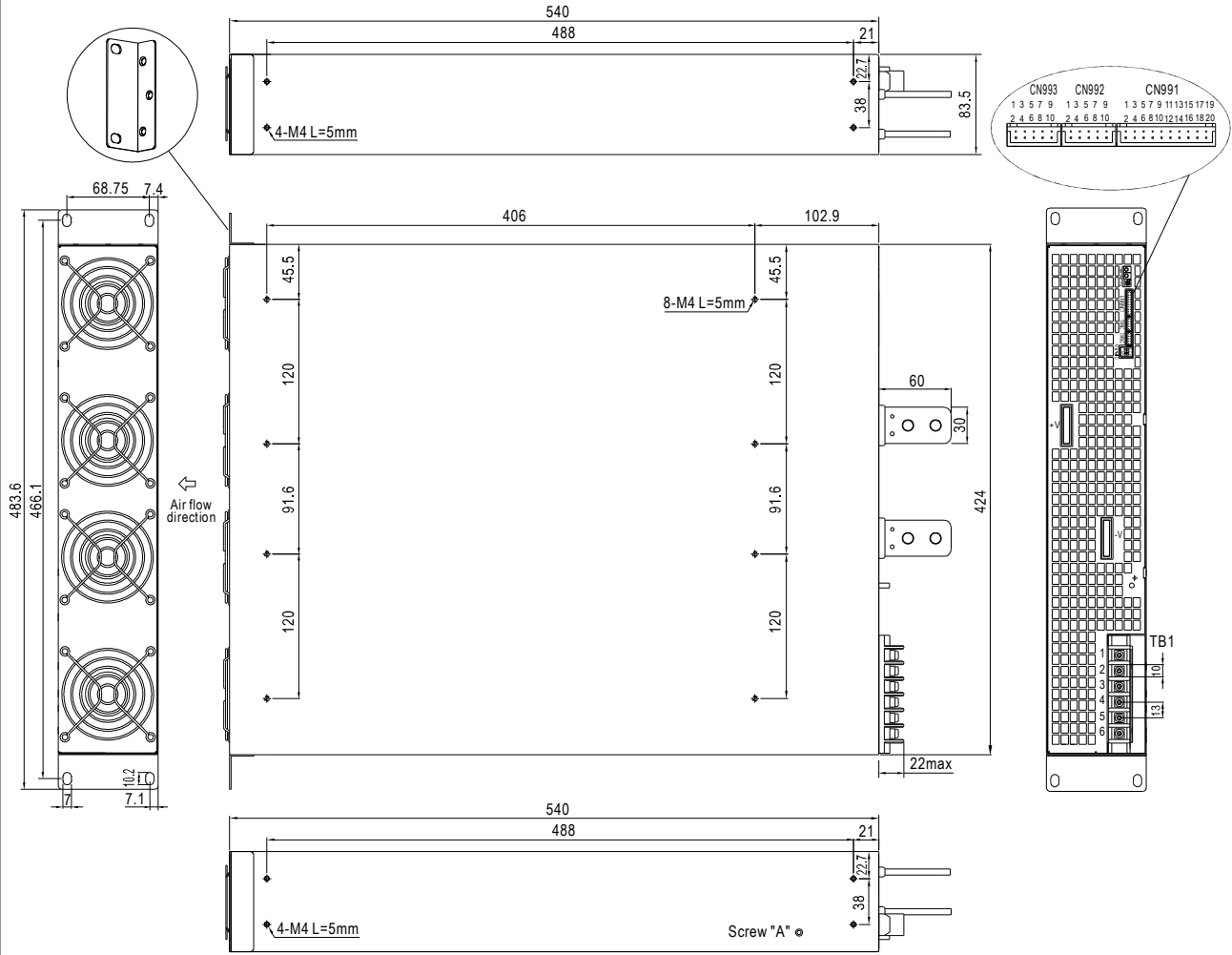

Fig 9.2



**Mechanical Specification**

Case No.234A Unit:mm



Terminal Pin No. Assignment

Pin No.	Assignment	Pin No.	Assignment
1	AC/L1	4	AC/N2
2	AC/N1	5	AC/L3
3	AC/L2	6	AC/N3

Control Pin No. Assignment(CN992,CN993) : HRS DF11-10DP-2DS or equivalent

Pin No.	Assignment	Pin No.	Assignment	Mating Housing	Terminal
1	CS-	6	PV+	HRS DF11-10DS or equivalent	HRS DF11-10SC or equivalent
2	CS+	7	PC-		
3	+S	8	RC-		
4	PV-	9	PC+		
5	-S	10	RC+		

Control Pin No. Assignment(CN991) : HRS DF11-20DP-2DS or equivalent

Pin No.	Assignment	Pin No.	Assignment	Pin No.	Assignment	Pin No.	Assignment	Mating Housing	Terminal
1	12V-AUX	6	AC-FAIL2-GND	11	OTP2-GND	16	DC-OK1-GND	HRS DF11-20DS or equivalent	HRS DF11-20SC or equivalent
2	DC-OK2-GND	7	-V	12	FAN-FAIL2-GND	17	AC-FAIL1-GND		
3	GND-AUX	8	AC-FAIL2	13	OTP1	18	FAN-FAIL1-GND		
4	DC-OK2	9	OTP2	14	DC-OK1	19	AC-FAIL1		
5	+V	10	FAN-FAIL2	15	OTP1-GND	20	FAN-FAIL1		

DIP Switch Position Assignment(DIP-SW): Please refer to the Function Manual.

Position	Assignment	Position	Assignment
1	OLP mode	3	PV mode
2	PC mode		



**Installation Manual**

Please refer to : <http://www.meanwell.com/webnet/search/InstallationSearch.html>